

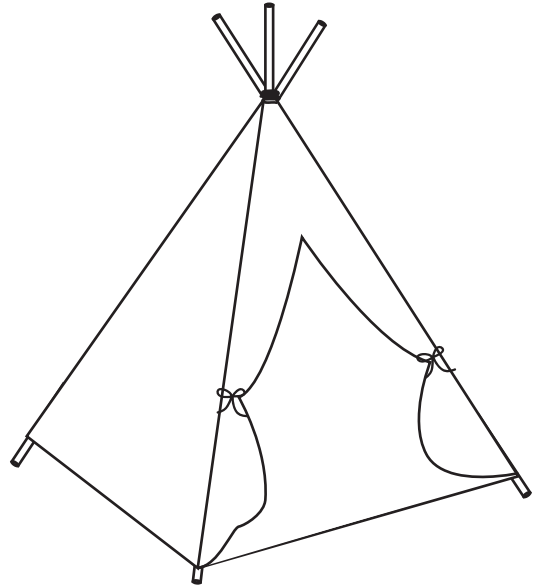

# TEEPEE ASSEMBLY INSTRUCTIONS

Thank you for purchasing a From the Avenue Teepee. This page shows all of the components included in the box. Please take the time to identify the hardware as well as the individual components of the product. As you unpack and prepare for assembly, place the contents on a carpeted or padded area to protect them from damage.

**WARNING: Adult Assembly Required**



## COMPONENTS:

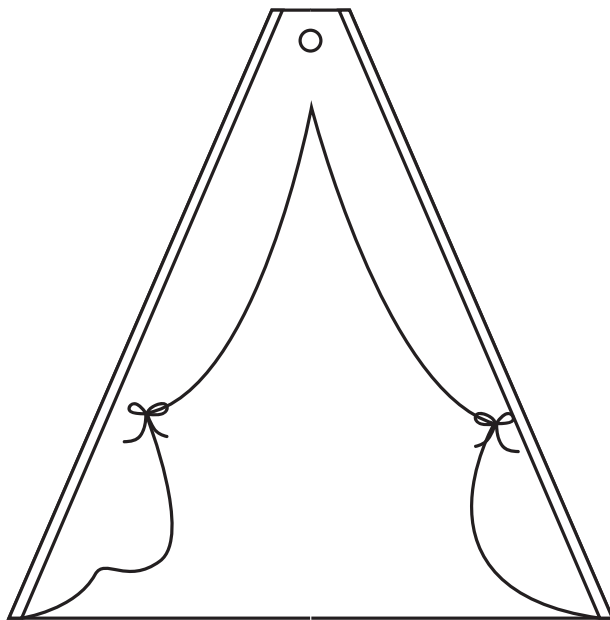

E- Teepee Fabric (1)

A- Top Pole (4)

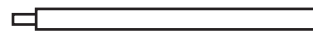

B- Plastic Connector (4)



C- Bottom Pole (4)



D- Stringing Cord (1)





# TEEPEE ASSEMBLY INSTRUCTIONS

## STEP 1

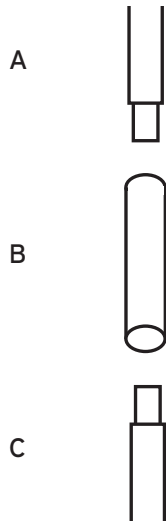

Insert the Top (A) and Bottom poles (C) into the Plastic Connectors (B)

## STEP 2

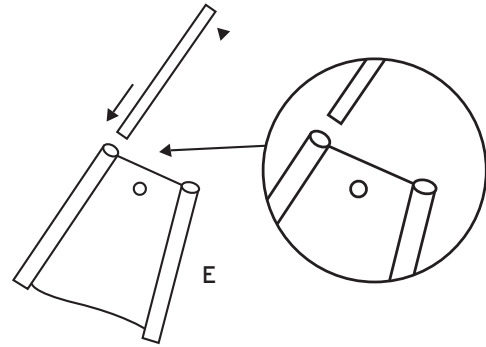

Insert the assembled poles into holes on the on the corners of the Teepee fabric (E) making sure that the holes in the top of the poles are at the top of the teepee.

## STEP 3 Top of Teepee

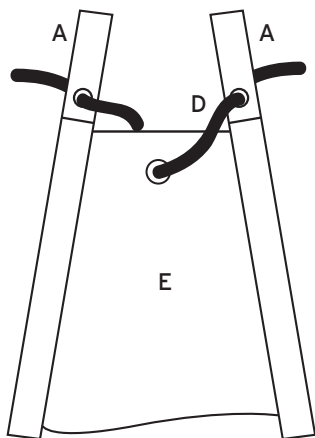

Lace the stringing cord (D) through the holes in the Top Poles (A) and the grommets in the teepee fabric (E)

## STEP 4

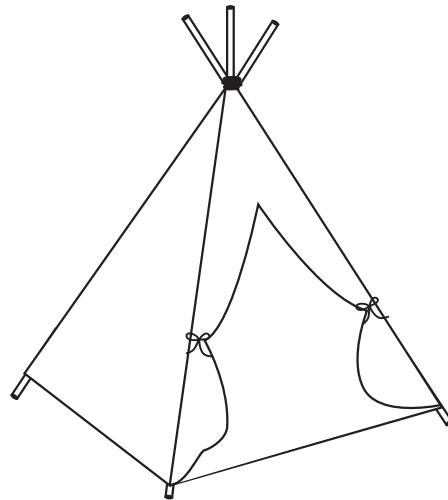

Spread the assembled teepee bottom corners out to make a square. Your teepee assembly is now complete.